

# FUEL LEAK DETECTION SYSTEM HOOKUP DETAILS

## SERVICE MANHOLE DETAIL

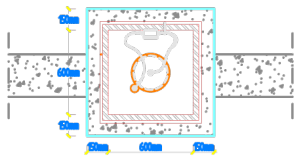

TOP VIEW

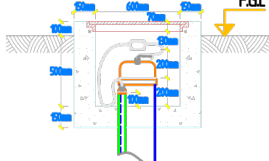

FRONT VIEW

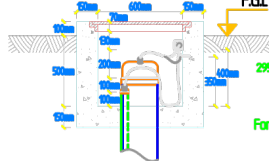

SIDE VIEW

## LEAK DETECTION CHAMBER DETAIL

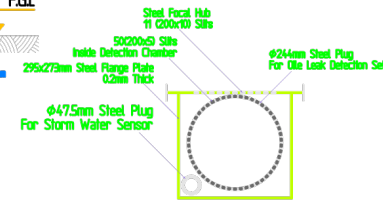

TOP VIEW

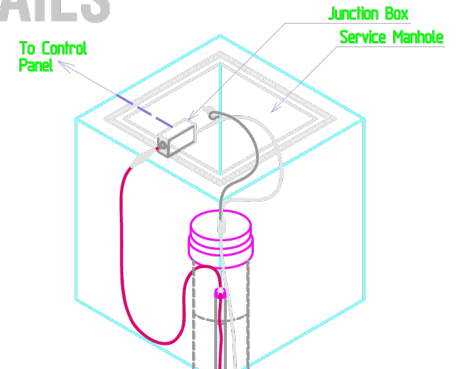

To Control Panel

## OIL LEAK DETECTION ELEMENT INSTALLATION DETAILS

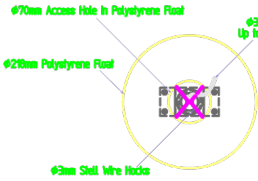

TOP VIEW

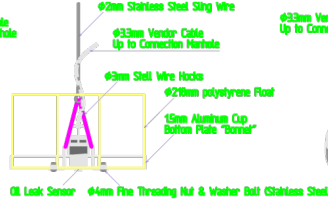

SIDE VIEW

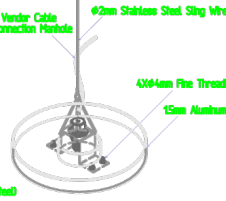

ISOMETRIC VIEW

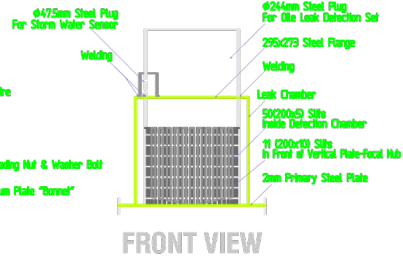

FRONT VIEW

Inspection Well

## FUEL OIL DETECTION ELEMENT

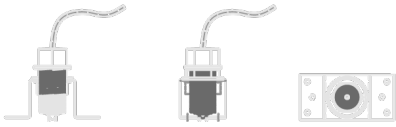

FRONT VIEW SIDE VIEW TOP VIEW

## STORM WATER SENSOR

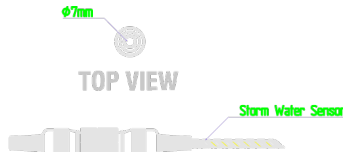

TOP VIEW FRONT VIEW

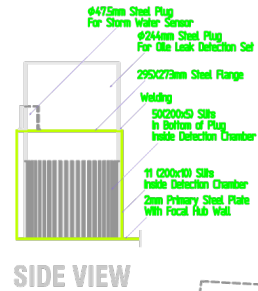

SIDE VIEW

PROTECTED (( MONITORED )) AREA

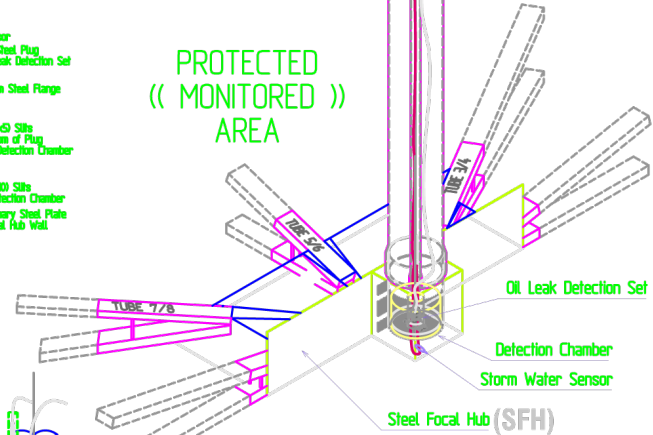

ISOMETRIC VIEW OVER ALL

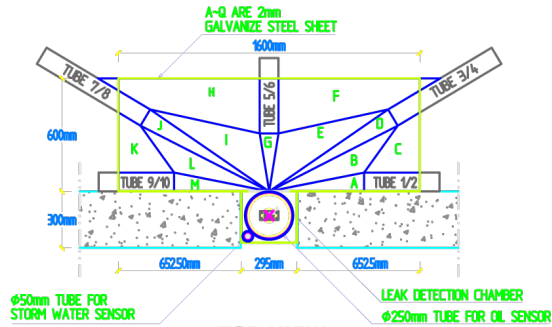

TOP VIEW BOTTOM SET OUT

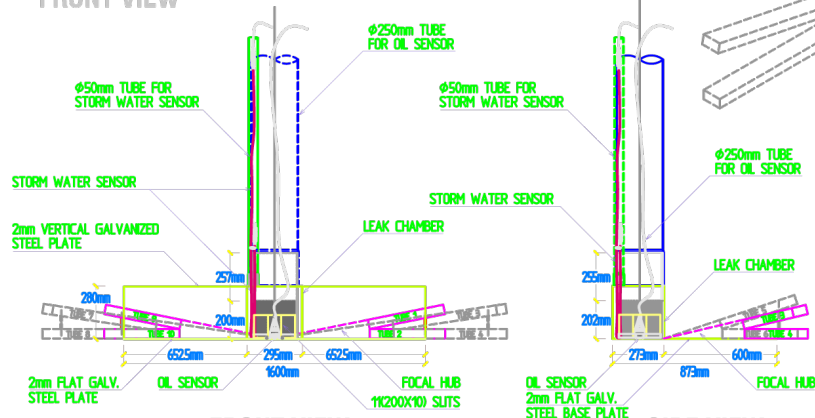

FRONT VIEW BOTTOM SET OUT

SIDE VIEW BOTTOM SET OUT